

# coaxial valve

## type FCF-K 80

### 5-FCF-K 80

valve type with pilot valve



**2/2 way valve** externally controlled  
**pressure range** PN 0-40 bar  
**orifice** DN 80 mm  
**connection** flange  
**function** valve  
 normally closed  
**symbol** NC

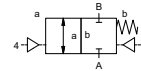

 Above stated body materials refer to the valve port connections that get in contact with the media only!

**design** pressure balanced, with spring return  
**body materials** ① aluminium ②  
 ③ ⑤  
 ④ ⑥  
**valve seat** synthetic resin on metal  
**seal materials** NBR, PU PTFE, FPM, PE

**details needed for main valve**

- orifice
- port
- function NC
- operating pressure
- flow rate
- media
- media temperature
- ambient temperature
- type of actuation

**details needed for pneumatic actuation**

- nominal voltage
- type of protection
- actuation pressure range min/max
- pilot valve type

**details needed for hydraulic actuation**

- actuation pressure range min/max
- hydraulic control valve function

 The valves' technical design is based on media and application requirements. This can lead to deviations from the general specifications shown on the data sheet with regards to the design, sealing materials and characteristics.

 If order or application specifications are incomplete or imprecise there exists a risk of an incorrect technical design of the valve for the required application. As a consequence, the physical and / or chemical properties of the materials or seals used, may not be suitable for the intended application.

general specifications		options
ports	FCF-K flanges PN 16 / 40	
function	NC	
pressure range	bar 0-16 / 0-40	
Kv value	m <sup>3</sup> /h 122,0	
vacuum	leak rate	< 10 <sup>-4</sup> mbar·l·s <sup>-1</sup>
pressure-vacuum	P <sub>1</sub> ↔ P <sub>2</sub>	pressure side max. 40 bar vacuum side leak rate upon request
back pressure	P <sub>2</sub> > P <sub>1</sub>	available (max. 16 bar)
media	emulsions - oils - neutral gases	other medias upon request
abrasive media		
damping	opening closing by throttles on pilot valve	
flow direction	A ↔ B as marked	bi-directional upon request (max. 16 bar)
switching cycles	1/min 50	
switching time	ms opening 350-3000 closing 350-3000	
media temperature	°C direct mounted pilot valve 60	> 60 °C upon request
ambient temperature	°C direct mounted pilot valve 50	> 50 °C upon request
flush ports		
leak ports		
limit switches		
manual override	via pilot valve	
approvals		upon request
mounting		
weight	kg FCF-K 11,5	
additional equipment	sensor / manometer connection G 1/4	

electrical specifications		options
nominal voltage	U <sub>n</sub> DC 24 V	special voltage upon request
	U <sub>n</sub> AC 230 V 50 Hz	special voltage upon request
power consumption	DC 4,8 W	
	AC pick up 11,0 VA holding 8,5 VA	
protection	IP65 (P54) acc. DIN 40050	
energized duty rating	ED 100%	
connection	plug acc. DIN EN 175301-803 form B, 4 positions x90° / wire diameter 6-8 mm	connector acc. VDMA
optional	M12x1 connector acc. DESINA	
additional equipment	illuminated plug with varistor	
max. temperature	media 60°C	
	ambient 50°C	
explosion proof	E Ex e II T5 nominal voltage U <sub>n</sub>	DC 24 V 3,25 W
	power consumption	AC 230 V 50 Hz 2,90 W

pneumatic specifications		options
actuation pressure range	bar 4-10	3-10 upon request
air consumption	cm <sup>3</sup> /stroke 100	
cycle speed	main valve speed variable by throttleson pilot valve	
control	preferably 5/2 way pilot valve	
pilot valve interface	NAMUR acc. VDI / VDE 3845	ISO 1 acc. DIN 5599/1
actuator ports	2/4 G 1/4	G 3/8

hydraulic specifications		options
actuation pressure range	bar 30-60	
control	preferably 4/2 way control valve	
actuator ports	X/Y G 1/4	NPT 1/4
by media		

■ specifications not highlighted are standard  
 specifications highlighted in grey are optional

# type **FCF-K 80**

function: **NC**  
closed when not energized

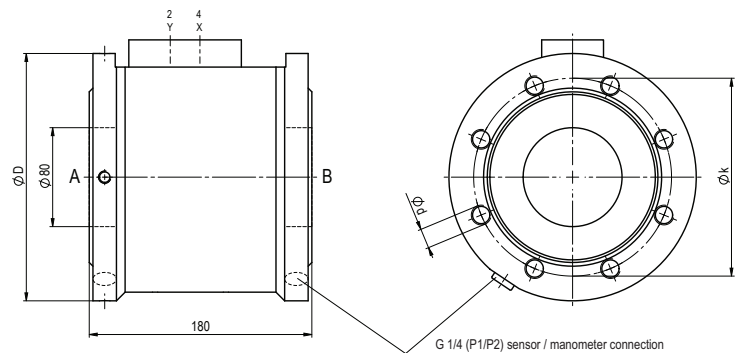

flanges PN	DIN	ØD	Øk	Ød
16	EN 1092-1	200	160	M16
40	EN 1092-1	200	160	M16

## pneumatic actuation

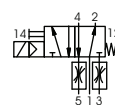

5/2 way pilot valve  
flow rate 700 l/min  
pressure range 3-10 bar G 1/8

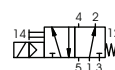

5/2 way pilot valve ISO 1  
flow rate 700 l/min  
pressure range 3-10 bar G 1/4